

Plug In Easy CookingPRO Counter for 2 1PH Units

ITEM # _____

MODEL # _____

NAME # _____

SIS # _____

AIA # _____



352080 (Z2VVADBQZA)

Easy CookingPRO Mobile Counter, suitable for 2 Plug-in appliances with four 1-phase sockets

Short Form Specification

Item No. _____

Plug in mobile cooking station in heavy duty AISI 304 stainless steel. Can be combined with up to two Easy CookingPRO table top units 1PHASE (Plug Type Schuko): flat induction hobs, induction wok, induction griddle. Plate holder shelf coupled with tempered glass and lighting for a better visibility from guest side. Automatic ventilation adjustment according to cooking intensity thanks to Easy CookingPRO Match function. Integrated air filtration system - Easy CookingPRO Ventilation - to absorb efficiently grease particles and bad odours in the working area. It is a 2-stage system with stainless steel and ceramic activated carbon filters easy to remove for cleaning operations. For additional storage space, up to two optional neutral 30 lt drawers are available.

Counter Plug Type: IEC/EN 60309-1/2 - 32 Amps. Mounted on 4 swiveling wheels (2 with brakes).

Main Features

- Compact, lightweight and easy to move.
- Plate holder shelf coupled with tempered glass and lighting for a better visibility from guest side.
- Designed for Easy CookingPRO Match function for automatic regulation of fan speed according to cooking intensity. Can be activated exclusively with Easy CookingPRO stand alone units.
- Easy CookingPRO Ventilation is a low noise air filtration system to absorb efficiently grease particles and bad odours in the working area. It is a 2-stage filtering system with stainless steel fat filters and ceramic activated carbon ones.
- 30 lt neutral drawer - accepting N° 1 GN1/1 - is available as optional accessory.
- Through the user interface with soft touch buttons the operator can: - vary the 4 fan speed; - switch on the LED lighting system of the cooking area; - display indications on maintenance operations (e.g. on filters) or any anomalous operating conditions.
- Can be combined with up to two tabletop appliances LiberoPro 1PHASE (Plug Type Schuko): flat induction hobs, induction wok, induction griddle.

Construction

- Heavy duty AISI 304 Stainless steel construction.
- Mounted on 4 swivelling wheels with brakes on the 2 front wheels (on the operator side).
- Frontal panel in AISI 304 can be customized requiring a special execution.
- Grease and odours filters are easily accessible and removable from operator's side for efficient maintenance without any tool.
- Side support frames each holding n.2 GN 1/9 containers and n.1 tools holder. All included in the standard delivery and easily removable for better cleanliness.
- Plug type: IEC/EN 60309-1/2 - 32 amps.
- IPx4 water protection.

Included Accessories

- 2 of Carbon filter for Mobile Counter PNC 650190
- 2 of Labyrinth grease filter with stainless steel grid for Mobile Counter PNC 650191
- 1 of Support frame for containers including 2 x 1/9 GN trays and 1 kitchen tool holder for Mobile Counter, left side PNC 650192
- 1 of Support frame for containers including 2 x 1/9 GN trays and 1 kitchen tool holder for Mobile Counter, right side PNC 650193

Optional Accessories

- Tilting side shelf for Mobile Counter PNC 650005
- Neutral drawer for Mobile Counter PNC 650189
- Carbon filter for Mobile Counter PNC 650190
- Labyrinth grease filter with stainless steel grid for Mobile Counter PNC 650191

APPROVAL: _____



Plug In Easy CookingPRO Counter for 2 1PH Units

- Support frame for containers including 2 x 1/9 GN trays and 1 kitchen tool holder for Mobile Counter, left side PNC 650192
- Support frame for containers including 2 x 1/9 GN trays and 1 kitchen tool holder for Mobile Counter, right side PNC 650193
- Kitchen tool holder to be inserted into support frame for Mobile Counter PNC 650194
- Side paper towel support PNC 650195
- Cover in PVC for Mobile Counter 2 modules PNC 651003



Plug In
Easy CookingPRO Counter for 2 1PH Units

The company reserves the right to make modifications to the products without prior notice. All information correct at time of printing.

2026.06.15

Front

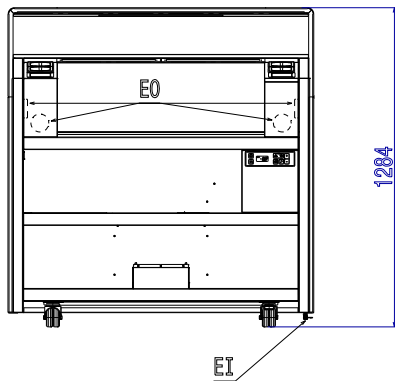

Side



EI = Electrical inlet (power)
EO = Electrical Outlet

Top

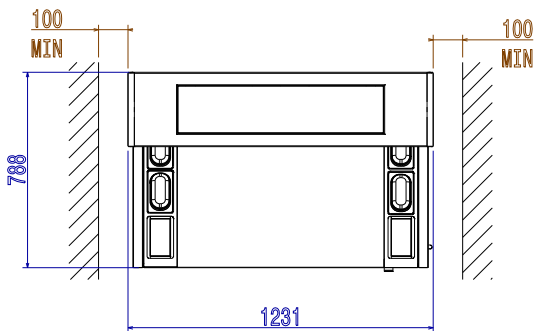

Electric

Supply voltage: 380-415 V/3N ph/50/60 Hz
Electrical power, max: 14.5 kW
Plug type: IEC/EN 60309-1/2

Key Information:

Frontal power sockets available for Plug-in Units: 4 x 1 Phase Plugs (Plug Type Schuko)
External dimensions, Width: 1231 mm
External dimensions, Depth: 788 mm
External dimensions, Height: 1284 mm
Net weight: 155 kg